



FENSTER- & TÜRERSATZTEILE KATALOG



Ihr starker Partner im Ersatzteilgeschäft!

Sehr geehrte Damen und Herren,

als Ihr kompetenter Fachhändler für Fenster, Tür & Sicherheitstechnik, haben wir tausende Ersatzteile auf Lager und garantieren somit, eine unkomplizierte, schnelle und günstige Lösung.

Für Ihre Fragen steht Ihnen der Geschäftsführer der Firma ToniTec GmbH, Enrico Verch, gerne persönlich zur Verfügung. Ebenso beraten Sie gerne unsere Fenster- und Türexperten Jens Rothe (Vertriebsleitung) und John-Patrick Winkel (Großkundenservice).

Sie erreichen uns telefonisch montags bis freitags zwischen 7.30 Uhr und 17.00 Uhr unter 03332 308 51-45. Alternativ kontaktieren Sie uns gerne unter grosshandel@tonitec.com, besuchen uns an eine unserer Verkaufsbüros in 16278 Angermünde, in 12627 Berlin, in 45966 Gladbeck oder in unserem Hauptsitz in 16303 Schwedt/Oder oder wir besuchen Sie vor Ort.



Jens Rothe

+49 (0) 3332 30851-15
J.ROTHE@TONITEC.COM



John-Patrick Winkel

MOBIL: +49 (0) 172 5977215
J.WINKEL@TONITEC.COM



Marcel Baumert

+49 (0) 3332 30851-12
M.BAUMERT@TONITEC.COM

Gerne senden wir Ihnen ein kostenloses Muster zu.



TONITEC GMBH
ACKERSTR. 4, 16303 SCHWEDT/ODER
TEL. +49 (0) 3332 308 51-0
FAX +49 (0) 3332 308 51-90
KUNDENSERVICE@TONITEC.COM
WWW.TONITEC.COM

UST - ID NR.: DE290253519
GLN: 42 6026459 000 6
WEEE-REG-NR.: DE 24706899

AMTSGERICHT NEURUPPIN HRB 10583
GESCHÄFTSFÜHRER:
ENRICO VERCH UND KEVIN LANGBECKER



BRIEFKASTEN SCHLÖSSER



BRIEFKASTEN SCHLÖSSER

ToniTec Briefkastenschloss TTBKS1920 M19 gleichschließend

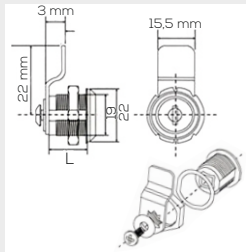

Bohrmaß: 19 mm
Gewindekörperlänge: 16 mm – 30 mm
gleichschließend
inkl. 2 Schlüssel und Metallkern

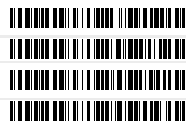

4260373823781

T2020110001323-001

M19 L=16 mm



4260373823798

T2020110001323-002

M19 L=20 mm



4260373823804

T2020110001323-003

M19 L=25 mm



4260373823811

T2020110001323-004

M19 L=30 mm

ToniTec Briefkastenschloss TTBKS1920 M19 verschiedenschließend

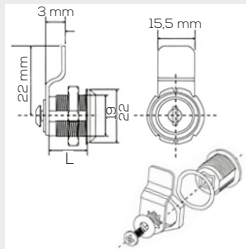

Bohrmaß: 19 mm
Gewindekörperlänge: 16 mm – 30 mm
verschiedenschließend
inkl. 2 Schlüssel und Metallkern



4260264591782

T2020110001126-001

M19 L=16 mm



4061334009646

T2020110001126-002

M19 L=20 mm



4260264591805

T2020110001126-003

M19 L=25 mm



4260264591812

T2020110001126-004

M19 L=30 mm

ToniTec Briefkastenschloss TTBKS1910 M19



verschiedenschließend

Bohrmaß: 19 mm

Gewindekörperlänge:
10 mm

inkl. 2 Schlüssel

T2020110001143



4260428554943

ToniTec Briefkastenschloss TTBKS1910



gleichschließend

Bohrmaß: 19 mm

Gewindekörperlänge:
10 mm

inkl. 2 Schlüssel

T2020110001322



4260428554967



ToniTec Mehrschlüssel

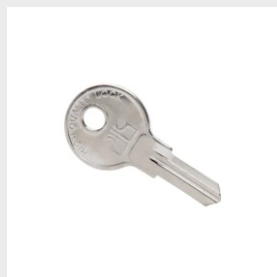

zu Briefkastenschloss
TTBKS1910, TTBKS1916
TTBKS1920

Material: Messing,
vernickelt

T2020110001186



4061 33401 831 0

ToniTec Riegel Set



Für Briefkastenschloss
TTBKS1910, TTBKS1920

1 Riegel Länge 35 mm

1 Riegel Länge 38 mm

1 Haken Riegel
Länge 47 mm

T2020110001187



4061 33401 832 7

ToniTec Riegel für Briefkastenschloss



Länge: 38 mm

TTBKS1910, TTBKS1920

T2020110001751



4260373825020

ToniTec Haken Riegel für Briefkastenschloss



Länge: 47 mm

TTBKS1910, TTBKS1920

T2020110001752



4260373825037

ToniTec Riegel für Briefkastenschloss



Länge: 35 mm

TTBKS1910, TTBKS1920

T2020110001750



426037382501 3



ECKLAGER / ECKBAND

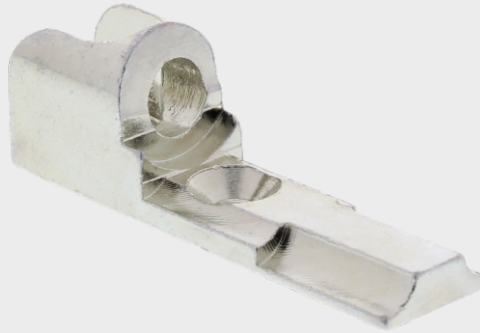

Inhaltsverzeichnis

AUBI SIEGENIA	Seite 1
FEPS	Seite 1
SIEGENIA	Seite 1
TONITEC	Seite 2 und 3

ECKLAGER

AUBI Siegenia Reparatur-Set EW001



SIEGENIA AUBI®
SOLUTIONS INSIDE

- 1x AUBI Ecklager EB001
- 1x AUBI Eckwinkel EW001
- 1x AUBI Abdeckkappe EK001 weiß
- 1x AUBI Abdeckkappe EK211 weiß



T2020110004311



4061 334027787

FEPS Flügellager FE-FL001



FEPS

Ersatz für Eckwinkel
EW203 Marke Aubi
Serie A300

mit einem weiteren
Befestigungspunkt

Maße: 85 mm x 53 mm



T2021081004932



4064692000201

FEPS Ecklagerset universal



FEPS

Eckband und Flügellager
Ersatz für
EW203 und EB003
Marke Aubi Serie A300

Bohrabstand Löcher
vertikal: 17 mm

Bohrabstand Löcher
horizontal: 28 mm



T2022051001102



4061 3341 26299

FEPS Ecklager FE-EL001

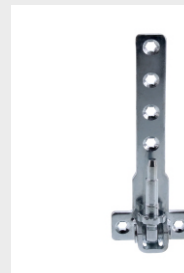

FEPS

Ersatz für Eckband
EB003 Marke Aubi
Serie A300

Bohrabstand Löcher
vertikal: 17 mm

Bohrabstand Löcher
horizontal: 28 mm



T2021081004931



4064692000157

Siegenia Reparatur-Set Ecklager



SIEGENIA®
brings spaces to life

DIN links

- 1x Siegenia Ecklager
H-12/18 RFA A0175,
- 1x Siegenia Falzeckband
H-12/18-9 A0175 ELB6
- 1x Siegenia Distanzstück
H-12/18-9 genutet



T2020110001234



4061 33401 8341

Siegenia Reparatur-Set Ecklager



SIEGENIA®
brings spaces to life

DIN rechts

- 1x Siegenia Ecklager
H-12/18 RFA A0175
- 1x Siegenia Falzeckband
H-12/18-9 A0175 ELB6
- 1x Siegenia Distanzstück
H-12/18-9 genutet



T2020110001235



4061 33401 8358



ToniTec Reproduktion GEZE Nr. 6678



Fensterwerkstoff:
Aluminium

Nachfertigung aus Stahl,
silber verzinkt

Maße: 56 x 15 x 19 mm



T2020110000444



42604931 77542

ToniTec Reproduktion GEZE Nr. 8301



Fensterwerkstoff:
Aluminium

Nachfertigung aus Stahl,
silber verzinkt

Maße: 56 x 15 x 19 mm



T2020110000211



42604657 20950

ToniTec Reproduktion Roto 65815 5070

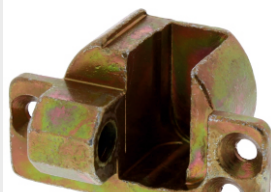

Ersatzteil für Ecklagertopf
65815 5070 von
Roto EUROTO

Maße: Topf 33 x 20 mm
Befestigungsplatte
20 x 55 mm

DIN rechts



T2020110000432-001



42604931 77405

ToniTec Reproduktion Roto 65815 5070



Ersatzteil für Ecklagertopf
65815 5070 von
Roto EUROTO

Maße: Topf 33 x 20 mm
Befestigungsplatte
20 x 55 mm

DIN links



T2020110000432-002



42604931 77412

ToniTec Reproduktion Siegenia Nr. 11

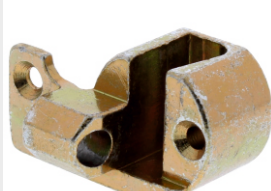

Ersatzteil für Ecklagertopf
Nr. 11 von Siegenia

Maße: 70 x 22/34 mm

Topfdurchmesser: 34 mm

DIN rechts



T2020110000429-001



42604931 76880

ToniTec Reproduktion Siegenia Nr. 11

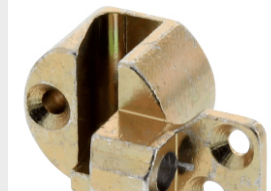

Ersatzteil für Ecklagertopf
Nr. 11 von Siegenia

Maße: 70 x 22/34 mm

Topfdurchmesser: 34 mm

DIN links



T2020110000429-002



42604931 76887

ECKLAGER / ECKBAND

ToniTec Reproduktion Ecklagertopf



Ersatzteil für Siegenia
Topflager Nr. 4

Maße: Topf 33 x 20 mm
Befestigungsplatte
16 x 63 mm



DIN Rechts

T2020110000428-001



42604931 76866

ToniTec Reproduktion Ecklagertopf



Ersatzteil für Siegenia
Topflager Nr. 4

Maße: Topf 33 x 20 mm
Befestigungsplatte
16 x 63 mm



DIN Links

T2020110000428-002



42604931 76873

ToniTec Reproduktion Siegenia



Ecklager höhenverstellbar
als Nachbau

Material: Stahl verzinkt

Maße: 52 x 15 mm



Lochabstand: 20 mm

T2020110001765



4260373825297



SCHLISSBLECHE FÜR TÜREN

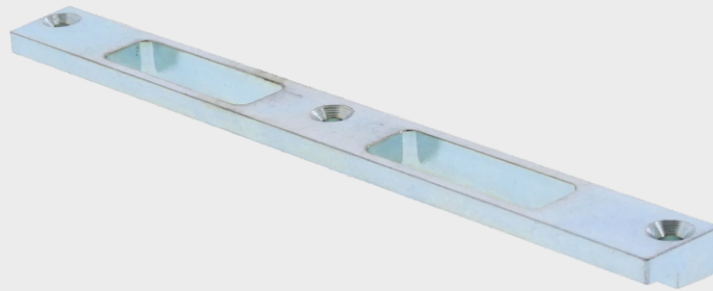

Inhaltsverzeichnis

FEPS	Seite 1 bis 4
TONITEC	Seite 5 und 6

SCHLIESSBLECHE

FEPS Reparaturschließblech Zimmertür FE-RS001

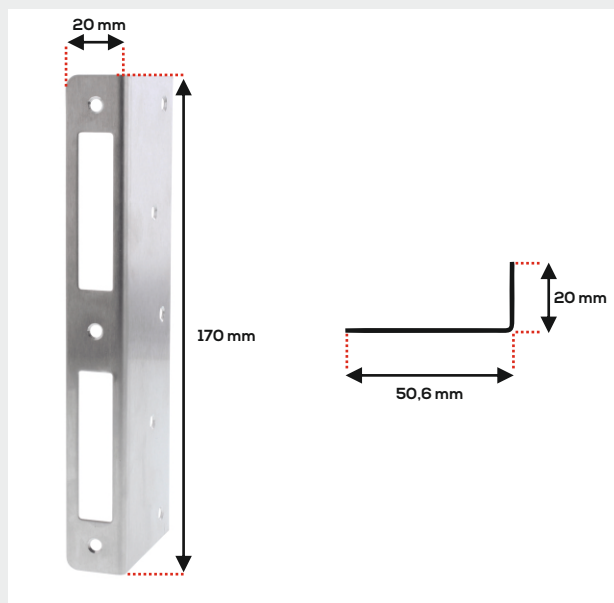

Material: Edelstahl
Oberfläche: gebürstet
Ausrichtung: universal
Maß: 170 mm x 50,6 mm x 20 mm

T2021121005613



FEPS Reparaturschließblech Haustür FE-RS002

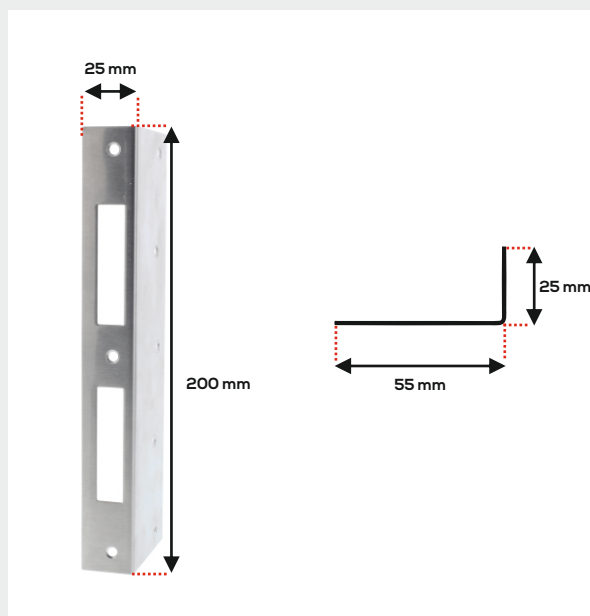

Material: Edelstahl
Oberfläche: gebürstet
Ausrichtung: universal
Maße: 200 mm x 55 mm x 25 mm

T2021121005614



SCHLISSBLECHE



FEPS Hinterfütterung für Schließblech RS

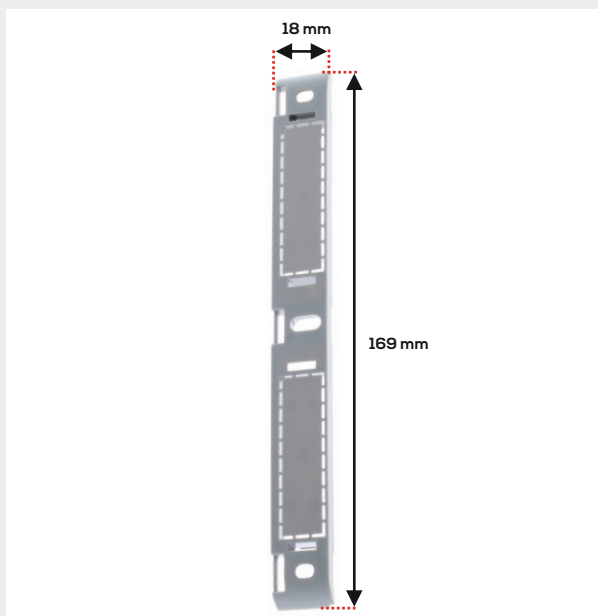

FEPS

Maße: 18 mm x 169 mm

Verwendbar für Schließblech FE-RS001 + FE-RS002

T2021121005615



4064692000577

FEPS Winkelschließblech 25x25x250mm FE-RS003 Edelstahl gebürstet

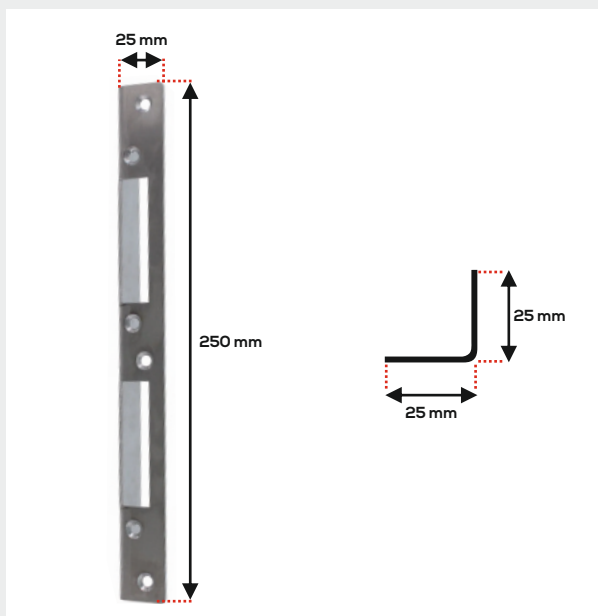

FEPS

Material: Edelstahl

Oberfläche: gebürstet

Maße: 25 mm x 25 mm x 250 mm

Ausrichtung: universal

T2021061004474



4064692000348

SCHLIESSBLECHE

FEPS Winkelschließblech für Reparatur Stahlzarge FE-RS005-RS

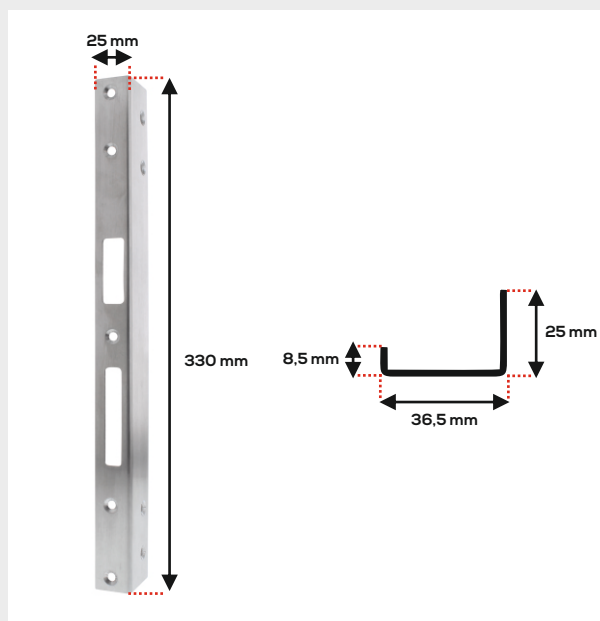

Material: Edelstahl
Oberfläche: gebürstet
DIN rechts - für DIN linke türen
Maße: 330 x 25 x 36,5 x 8,5 mm

T2022051001104



FEPS Winkelschließblech für Reparatur Stahlzarge FE-RS005-LS

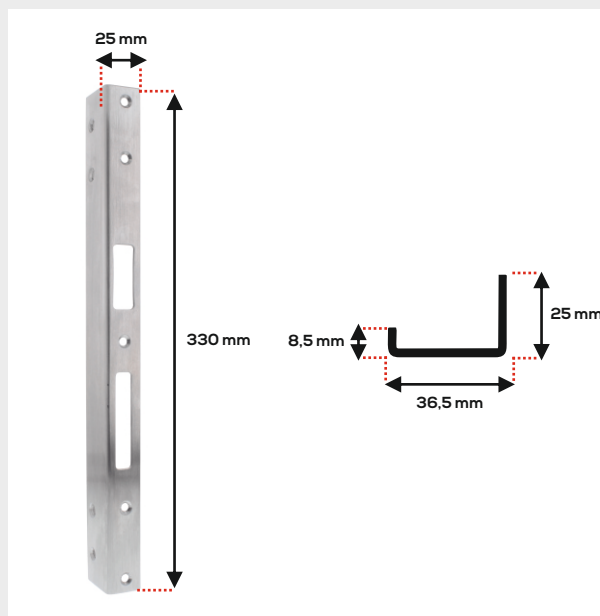

Material: Edelstahl
Oberfläche: gebürstet
DIN links für DIN rechte Türen
Maße: 330 x 25 x 36,5 x 8,5 mm

T2022051001103



SCHLIESSBLECHE



FEPS Winkelschließblech 50x25x350mm FE-RS004 Edelstahl gebürstet

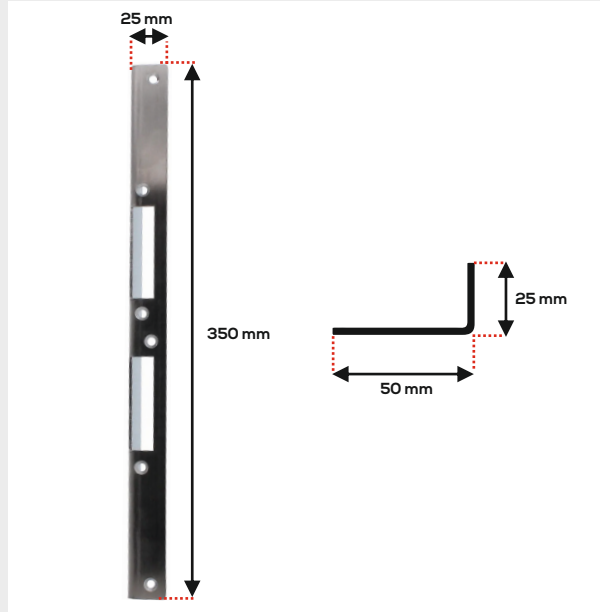

Material: Edelstahl
Oberfläche: gebürstet
Maße: 50 x 25 x 350 mm
Ausrichtung: universal

T2021061004475



SCHLIESSBLECHE

ToniTec Tür- Schonungsblech FE-SCHB001

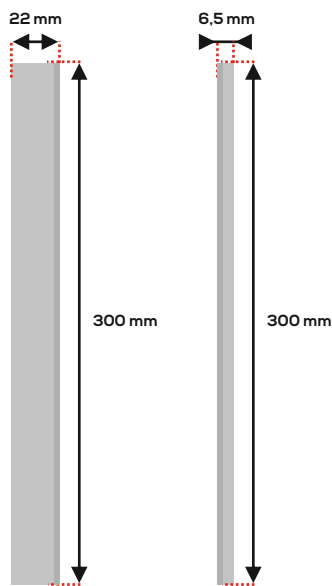

Material: Edelstahl
Maße: 300 x 22 x 6,5 mm

T2021011003727



Reparatur Tür Schließblech Winkelschließblech (klein) Edelstahl matt kantig 065413



Material: Edelstahl
DIN-Ausrichtung: universal
Maße: 25 x 25 x 250 mm

T2020110009108



SCHLIESSBLECHE



ToniTec Haustür-Schließblech Stahl verzinkt ls/rs verwendbar

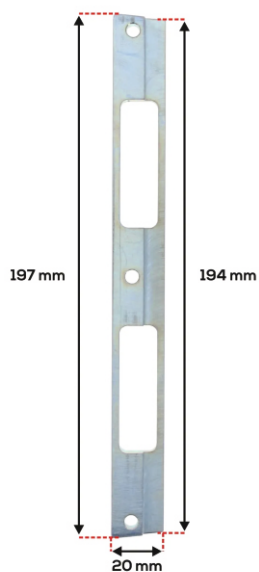

Ersatz für Meeth 003008000000170
Maße: 197 mm x 194 mm x 20 mm, Tiefe: 10 mm / 6 mm
Ausrichtung: universal

T2020110005384



4061 334027886

ToniTec Tür Reparatur-Schließblech Winkelschließblech (groß) 350 x 50 x 25 mm



Material: Edelstahl matt
Form: kantig
Ausrichtung: universal
Maße: 350 x 50 x 25 mm

T2020110009109



4061 334065444



SCHLOSSKÄSTEN

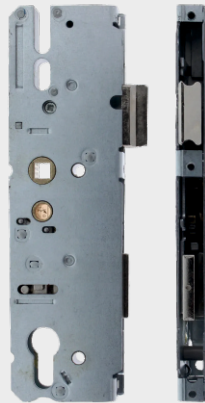

Inhaltsverzeichnis

DORNMAß 26	Seite 1
DORNMAß 30	Seite 1
DORNMAß 33	Seite 1
DORNMAß 35	Seite 1 bis 4
DORNMAß 40	Seite 4 und 5
DORNMAß 45	Seite 6 bis 9
DORNMAß 50	Seite 9 und 10
DORNMAß 55	Seite 10 bis 13
DORNMAß 60	Seite 13
DORNMAß 65	Seite 13 bis 15
DORNMAß 70	Seite 15
DORNMAß 80	Seite 15
DORNMAß 90	Seite 16
DORNMAß 100	Seite 16
NEBENSCHLOSSKÄSTEN	Seite 16 und 17

SCHLOSSKÄSTEN

Winkhaus Hauptschloss STV Typ 2 lose



**WINK
HAUS**

Dornmaß: 26 mm
Entfernung: 92 mm
Vierkantmaß: 8 mm

T2020110008582-009



4061 334099524

FUHR Schlosskasten Multisafe 855 GL



FUHR®

Dornmaß: 30 mm
Entfernung: 92 mm
Vierkantmaß: 8 mm

T2020110003505-007



4061 3340981 38

KFV Schlosskasten Typ 9050



KFV 

Dornmaß: 30 mm
Entfernung: 92 mm
Vierkantmaß: 10 mm

T2020110001040-001



4061 334045033

Winkhaus Hauptschloss STV Typ 2 lose



**WINK
HAUS**

Dornmaß: 30 mm
Entfernung: 92 mm
Vierkantmaß: 8 mm

T2020110008582-010



4061 334099531

Winkhaus Hauptschloss STV Typ 2 lose



**WINK
HAUS**

Dornmaß: 33 mm
Entfernung: 92 mm
Vierkantmaß: 8 mm

T2020110008582-011



4061 3341 03849

FUHR Schlosskasten Multisafe 855 GL



FUHR®

Dornmaß: 35 mm
Entfernung: 92 mm
Vierkantmaß: 8 mm
schraubbar

T2020110003505-006



4061 3340981 21



FUHR Schlosskasten Multisafe 855/855R



FUHR®

Dornmaß: 35 mm
Entfernung: 92 mm
Vierkantmaß: 8 mm

T2021091005074-001



4061 3340981 76

FUHR Schlosskasten Multisafe 859



FUHR®

Dornmaß: 35 mm
Entfernung: 92 mm
Vierkantmaß: 8 mm

T2021091005076-001



4061 3340981 90

KFV Schlosskasten Typ 8250



KFV

Dornmaß: 35 mm
Entfernung: 92 mm
Vierkantmaß: 10 mm

T2020110001040-002



4260264593601

KFV Hauptschloss für AS2750



KFV

Dornmaß: 35 mm
Entfernung: 92 mm
Vierkantmaß: 8 mm
mit doppelter
Rundstangenaufnahme

T2020110004424-001



4061 334039964

KFV Schlosskasten für AS2750

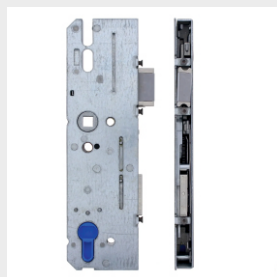

KFV

Dornmaß: 35 mm
Entfernung: 92 mm
Vierkantmaß: 8 mm
für flache Treibstangen

T2020110007676-001



426051 9567883

KFV Hauptschloss für AS2750



KFV

Dornmaß: 65 mm
Entfernung: 92 mm
Vierkantmaß: 10 mm
mit doppelter
Rundstangenaufnahme

T2020110004424-005



4061 3341 00923

SCHLOSSKÄSTEN

KFV Schlosskasten für AS3500

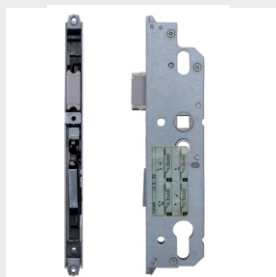

Dornmaß: 35 mm
Entfernung: 92 mm
Vierkantmaß: 10 mm

T2021101005166-009



4061 334099692

Maco Schlosskasten Z-TS

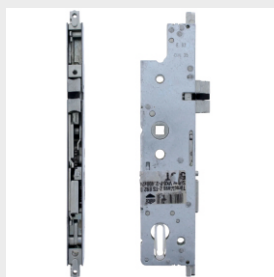

Dornmaß: 35 mm
Entfernung: 92 mm
Vierkantmaß: 8 mm

T2021101005167-005



4061 334099685

Winkhaus Hauptschloss STV-G3 SK TP3 BL



Dornmaß: 35 mm
Entfernung: 92 mm
Vierkantmaß: 10 mm

T2020110002263-001



4061 3340221 26

Winkhaus Hauptschloss STV-G3 SK TP3 BL

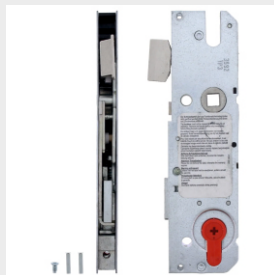

Dornmaß: 35 mm
Entfernung: 92 mm
Vierkantmaß: 8 mm

T2020110002266-001



4061 3340221 19

Winkhaus Hauptschloss STV Typ 2 lose



Dornmaß: 35 mm
Entfernung: 92 mm
Vierkantmaß: 8 mm

T2020110008582-001



4061 334046337

Winkhaus Hauptschloss STV-AV2

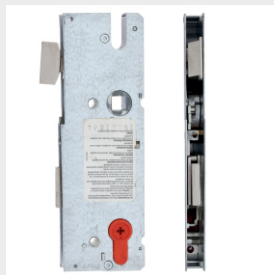

DIN links
Dornmaß: 35 mm
Entfernung: 92 mm
Vierkantmaß: 8 mm

T2021101005164-001



4061 334099364



Winkhaus Hauptschloss STV-AV3



**WINK
HAUS**

autoLock

Dornmaß: 35 mm

Entfernung: 92 mm

Vierkantmaß: 8 mm

T2021101005165-001



4061 33409941 8

FUHR Schlosskasten Multisafe 855 GL



FUHR®

Dornmaß: 40 mm

Entfernung: 92 mm

Vierkantmaß: 8 mm

schraubbar

T2020110003505-005



4061 33409811 4

FUHR Schlosskasten Multisafe 859



FUHR®

Dornmaß: 40 mm

Entfernung: 92 mm

Vierkantmaß: 8 mm

T2021091005076-004



4061 334099302

KFV Schlosskasten Typ 8250



KFV

Dornmaß: 40 mm

Entfernung: 92 mm

Vierkantmaß: 10 mm

T2020110001040-009



426026459361 8

KFV Hauptschloss für AS2750



KFV

Dornmaß: 40 mm

Entfernung: 92 mm

Vierkantmaß: 8 mm

mit doppelter
Rundstangenaufnahme

T2020110004424-003



4061 334039957

KFV Schlosskasten für AS2750



KFV

Dornmaß: 40 mm

Entfernung: 92 mm

Vierkantmaß: 8 mm

für flache Treibstangen

T2020110007676-007



4061 334027626

SCHLOSSKÄSTEN

KFV Schlosskasten für AS3500



KFV 

Dornmaß: 40 mm
Entfernung: 92 mm
Vierkantmaß: 8 mm

T2021101005166-006



4061 334099500

Winkhaus Hauptschloss STV-G3 SK TP3 BL



**WINK
HAUS**

Dornmaß: 40 mm
Entfernung: 92 mm
Vierkantmaß: 10 mm

T2020110002263-005



4061 3340221 64

Winkhaus Hauptschloss STV-G3 SK TP3 BL



**WINK
HAUS**

Dornmaß: 40 mm
Entfernung: 92 mm
Vierkantmaß: 8 mm

T2020110002266-003



4061 334098084

Winkhaus Hauptschloss STV-AV2

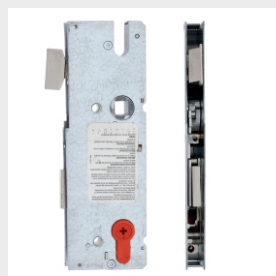

**WINK
HAUS**

DIN links
Dornmaß: 40 mm
Entfernung: 92 mm
Vierkantmaß: 8 mm

T2021101005164-002



4061 334099388

Winkhaus Hauptschloss STV-AV2

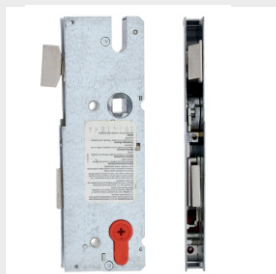

**WINK
HAUS**

DIN rechts
Dornmaß: 40 mm
Entfernung: 92 mm
Vierkantmaß: 8 mm

T2021101005164-009



4061 3341 03832

Winkhaus Hauptschloss STV-AV3



**WINK
HAUS**

autoLock
Dornmaß: 40 mm
Entfernung: 92 mm
Vierkantmaß: 8 mm

T2021101005165-002



4061 334099425



FUHR Schlosskasten Multisafe 855 GL



FUHR®

Dornmaß: 45 mm
 Entfernung: 92 mm
 Vierkantmaß: 8 mm
 schraubbar

T2020110003505-004



4061 3340981 07

FUHR Schlosskasten Multisafe 855/855R



FUHR®

Dornmaß: 45 mm
 Entfernung: 92 mm
 Vierkantmaß: 8 mm

T2021091005074-002



4061 3340981 83

FUHR Schlosskasten Multisafe 859



FUHR®

Dornmaß: 45 mm
 Entfernung: 92 mm
 Vierkantmaß: 8 mm

T2021091005076-002



4061 3340982 06

KFV Schlosskasten Typ 8250



KFV

Dornmaß: 45 mm
 Entfernung: 92 mm
 Vierkantmaß: 10 mm

T2020110001040-005



4260264593625

KFV Hauptschloss für AS2750



KFV

Dornmaß: 45 mm
 Entfernung: 92 mm
 Vierkantmaß: 8 mm
 mit doppelter
 Rundstangenaufnahme

T2020110004424-002



4061 3340399 40

KFV Hauptschloss für AS2750



KFV

Dornmaß: 45 mm
 Entfernung: 92 mm
 Vierkantmaß: 10 mm
 mit doppelter
 Rundstangenaufnahme

T2020110004424-004



4061 3340996 16

SCHLOSSKÄSTEN

KFV Schlosskasten für AS2750



KFV 

Dornmaß: 45 mm
Entfernung: 92 mm
Vierkantmaß: 10 mm
für flache Treibstangen

T2020110007676-003



4061 334047969

KFV Schlosskasten für AS2750



KFV 

Dornmaß: 45 mm
Entfernung: 92 mm
Vierkantmaß: 8 mm
für flache Treibstangen

T2020110007676-004



426051 9566473

KFV Schlosskasten für AS4540



KFV 

Dornmaß: 45 mm
Entfernung: 92 mm
Vierkantmaß: 8 mm

T2020110008923



4061 334048362

KFV Schlosskasten für AS3500



KFV 

Dornmaß: 45 mm
Entfernung: 92 mm
Vierkantmaß: 10 mm

T2021101005166-003



4061 334099470

KFV Schlosskasten für AS3500



KFV 

Dornmaß: 45 mm
Entfernung: 92 mm
Vierkantmaß: 8 mm

T2021101005166-007



4061 334099517

Maco Schlosskasten Z-TS



Dornmaß: 45 mm
Entfernung: 92 mm
Vierkantmaß: 8 mm

T2021101005167-001



4061 334099548



Maco Schlosskasten Z-TS



Dornmaß: 45 mm
Entfernung: 92 mm
Vierkantmaß: 10 mm

T2021101005167-002



4061 334099555

Winkhaus Hauptschloss STV-G3 SK TP3 BL



Dornmaß: 45 mm
Entfernung: 92 mm
Vierkantmaß: 10 mm

T2020110002263-003



4061 3340221 40

Winkhaus Hauptschloss STV-G3 SK TP3 BL

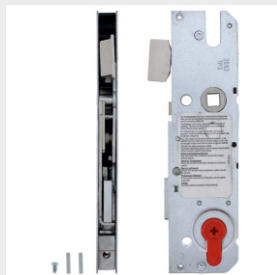

Dornmaß: 45 mm
Entfernung: 92 mm
Vierkantmaß: 8 mm

T2020110002266-002



4061 3340221 02

Winkhaus Hauptschloss STV Typ 2 lose



Dornmaß: 45 mm
Entfernung: 92 mm
Vierkantmaß: 8 mm

T2020110008582-004



4061 334046320

Winkhaus Hauptschloss STV-AV2

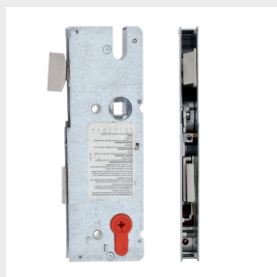

DIN rechts
Dornmaß: 45 mm
Entfernung: 92 mm
Vierkantmaß: 8 mm

T2021101005164-003



4061 334099357

Winkhaus Hauptschloss STV-AV2

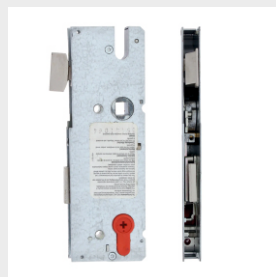

DIN rechts
Dornmaß: 45 mm
Entfernung: 92 mm
Vierkantmaß: 10 mm

T2021101005164-004



4061 334099340

SCHLOSSKÄSTEN

Winkhaus Hauptschloss STV-AV2

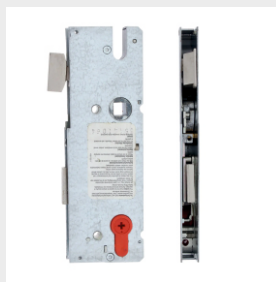

**WINK
HAUS**

DIN links

Dornmaß: 45 mm

Entfernung: 92 mm

Vierkantmaß: 10 mm

T2021101005164-007



4061 3341 0381 8

Winkhaus Hauptschloss STV-AV2

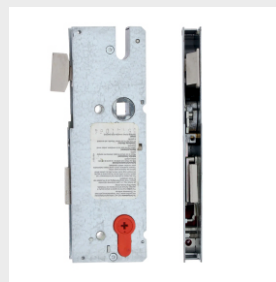

**WINK
HAUS**

DIN links

Dornmaß: 45 mm

Entfernung: 92 mm

Vierkantmaß: 8 mm

T2021101005164-008



4061 3341 0382 5

Winkhaus Hauptschloss STV-AV3



**WINK
HAUS**

autoLock

Dornmaß: 45 mm

Entfernung: 92 mm

Vierkantmaß: 8 mm

T2021101005165-003



4061 3340 9943 2

KFV Schlosskasten Typ 8250



KFV 

Dornmaß: 50 mm

Entfernung: 92 mm

Vierkantmaß: 10 mm

T2020110001040-006



426026459363 2

KFV Schlosskasten für AS2750

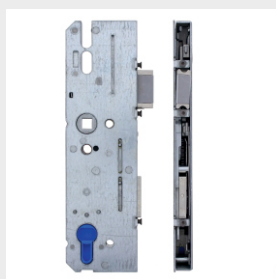

KFV 

Dornmaß: 50 mm

Entfernung: 92 mm

Vierkantmaß: 8 mm

für flache Treibstangen

T2020110007676-005



4061 3340 4795 2

KFV Schlosskasten für AS3500



KFV 

Dornmaß: 50 mm

Entfernung: 92 mm

Vierkantmaß: 10 mm

T2021101005166-005



4061 3340 9949 4



KFV Schlosskasten für AS3500



KFV

Dornmaß: 50 mm
Entfernung: 92 mm
Vierkantmaß: 8 mm

T2021101005166-008



4061 334099609

Winkhaus Hauptschloss STV Typ 2 lose



**WINK
HAUS**

Dornmaß: 50 mm
Entfernung: 92 mm
Vierkantmaß: 10 mm

T2020110008582-005



4061 33404631 3

Winkhaus Hauptschloss STV-AV2

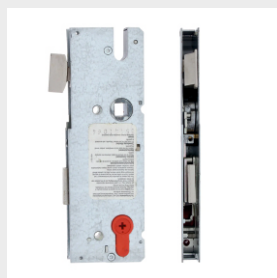

**WINK
HAUS**

DIN links
Dornmaß: 50 mm
Entfernung: 92 mm
Vierkantmaß: 8 mm

T2021101005164-005



4061 334099395

FUHR Schlosskasten Multisafe 855 GL



FUHR®

Dornmaß: 55 mm
Entfernung: 92 mm
Vierkantmaß: 10 mm
schraubbar

T2020110003505-002



426051 9567456

FUHR Schlosskasten Multisafe 855/855R



FUHR®

Dornmaß: 55 mm
Entfernung: 72 mm
Vierkantmaß: 8 mm

T2021091005074-003



4061 3341 01 050

FUHR Schlosskasten Multisafe 859



FUHR®

Dornmaß: 55 mm
Entfernung: 92 mm
Vierkantmaß: 8 mm

T2021091005076-003



4061 33409821 3

SCHLOSSKÄSTEN

FUHR Schlosskasten Multisafe 855 GL



FUHR®

Dornmaß: 55 mm
Entfernung: 92 mm
Vierkantmaß: 8 mm
schraubbar

T2020110003505-003



426051 9567463

KFV Schlosskasten Typ 8250



KFV

Dornmaß: 55 mm
Entfernung: 92 mm
Vierkantmaß: 10 mm

T2020110001040-008



4260264593649

KFV Schlosskasten Typ 8092

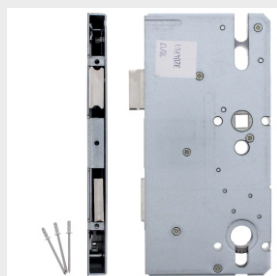

KFV

Dornmaß: 55 mm
Entfernung: 72 mm
Vierkantmaß: 10 mm

T2020110001040-013



4260373823569

KFV Schlosskasten Typ 8092



KFV

Dornmaß: 55 mm
Entfernung: 92 mm
Vierkantmaß: 10 mm

T2020110001040-014



4061 33409481 9

KFV Hauptschloss für AS2750



KFV

Dornmaß: 55 mm
Entfernung: 92 mm
Vierkantmaß: 10 mm
mit doppelter
Rundstangenaufnahme

T2020110004424-006



4061 3341 00930

KFV Hauptschloss für AS2750



KFV

Dornmaß: 55 mm
Entfernung: 92 mm
Vierkantmaß: 8 mm
mit doppelter
Rundstangenaufnahme

T2020110004424-007



4061 3341 00947



KFV Schlosskasten Typ 8772

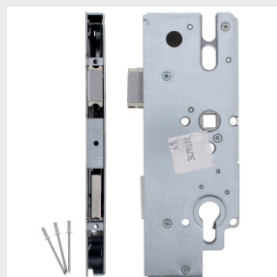

KFV 

Dornmaß: 55 mm
Entfernung: 72 mm
Vierkantmaß: 10 mm

T2020110001040-007



4260373823583

KFV Schlosskasten für AS2750



KFV 

Dornmaß: 55 mm
Entfernung: 92 mm
Vierkantmaß: 10 mm
für flache Treibstangen

T2020110007676-010



4061 334094833

KFV Schlosskasten für AS3500



KFV 

Dornmaß: 55 mm
Entfernung: 92 mm
Vierkantmaß: 10 mm

T2021101005166-001



4061 334099436

KFV Schlosskasten für AS3500

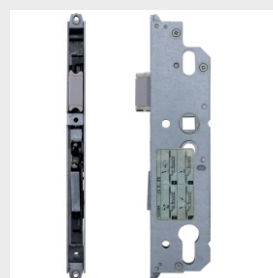

KFV 

Dornmaß: 55 mm
Entfernung: 92 mm
Vierkantmaß: 8 mm

T2021101005166-004



4061 334099487

KFV Schlosskasten für AS2750



KFV 

Dornmaß: 55 mm
Entfernung: 92 mm
Vierkantmaß: 8 mm
für flache Treibstangen

T2020110007676-006



426051 9566480

Maco Schlosskasten Z-TS



Dornmaß: 55 mm
Entfernung: 92 mm
Vierkantmaß: 10 mm

T2021101005167-003



4061 334099562

SCHLOSSKÄSTEN

Winkhaus Hauptschloss STV-G3 SK TP3 BL

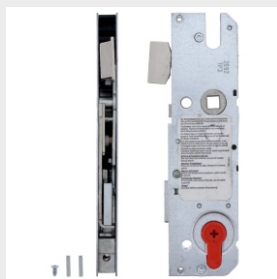

**WINK
HAUS**

Dornmaß: 55 mm
Entfernung: 92 mm
Vierkantmaß: 8 mm

T2020110002266-004



4061 334098091

Winkhaus Hauptschloss STV Typ 2 lose



**WINK
HAUS**

Dornmaß: 55 mm
Entfernung: 92 mm
Vierkantmaß: 8 mm

T2020110008582-007



4061 334098237

Winkhaus Hauptschloss STV-AV3



**WINK
HAUS**

autoLock
Dornmaß: 55 mm
Entfernung: 92 mm
Vierkantmaß: 8 mm

T2021101005165-004



4061 334099449

Winkhaus Hauptschloss STV-G3 SK TP3 BL



**WINK
HAUS**

Dornmaß: 55 mm
Entfernung: 92 mm
Vierkantmaß: 10 mm

T2020110002263-004



4061 3340221 57

KFV Schlosskasten Typ 8250



KFV

Dornmaß: 60 mm
Entfernung: 92 mm
Vierkantmaß: 10 mm

T2020110001040-015



4061 334098077

FUHR Schlosskasten Multisafe 855 GL



FUHR[®]

Dornmaß: 65 mm
Entfernung: 92 mm
Vierkantmaß: 10 mm
schraubbar

T2020110003505-001



426051 9567 449



KFV Schlosskasten Typ 8092

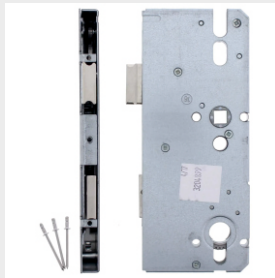

Dornmaß: 65 mm
Entfernung: 92 mm
Vierkantmaß: 10 mm

T2020110001040-004



4260373823552

KFV Schlosskasten Typ 8250



Dornmaß: 65 mm
Entfernung: 92 mm
Vierkantmaß: 10 mm

T2020110001040-016



4061 334098305

KFV Schlosskasten für AS2750



Dornmaß: 65 mm
Entfernung: 92 mm
Vierkantmaß: 10 mm
für flache Treibstangen

T2020110007676-002



426051 9566466

KFV Schlosskasten für AS3500



Dornmaß: 65 mm
Entfernung: 92 mm
Vierkantmaß: 10 mm

T2021101005166-002



4061 334099463

KFV Schlosskasten Typ 8772



Dornmaß: 65 mm
Entfernung: 72 mm
Vierkantmaß: 10 mm

T2020110001040-003



4260373823590

Maco Schlosskasten Z-TS



Dornmaß: 65 mm
Entfernung: 92 mm
Vierkantmaß: 10 mm

T2021101005167-004



4061 334099579

SCHLOSSKÄSTEN

Winkhaus Hauptschloss STV Typ 2 lose



**WINK
HAUS**

Dornmaß: 65 mm
Entfernung: 72 mm
Vierkantmaß: 8 mm

T2020110008582-002



4061 334046306

Winkhaus Hauptschloss STV Typ 2 lose



**WINK
HAUS**

Dornmaß: 65 mm
Entfernung: 72 mm
Vierkantmaß: 8 mm

T2020110008582-003



4061 334046290

Winkhaus Hauptschloss STV-G3 SK TP3 BL



**WINK
HAUS**

Dornmaß: 65 mm
Entfernung: 92 mm
Vierkantmaß: 10 mm

T2020110002263-002



4061 3340221 33

KFV Schlosskasten Typ 8092

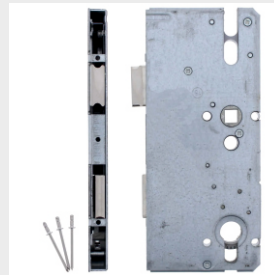

KFV 

Dornmaß: 70 mm
Entfernung: 92 mm
Vierkantmaß: 10 mm

T2020110001040-012



426046572071 4

Winkhaus Hauptschloss STV Typ 2 lose



**WINK
HAUS**

Dornmaß: 80 mm
Entfernung: 72 mm
Vierkantmaß: 8 mm

T2020110008582-006



4061 334046283

Winkhaus Hauptschloss STV-AV2



**WINK
HAUS**

DIN links
Dornmaß: 80 mm
Entfernung: 72 mm
Vierkantmaß: 8 mm

T2021101005164-006



4061 334099371



KFV Schlosskasten Typ 8092

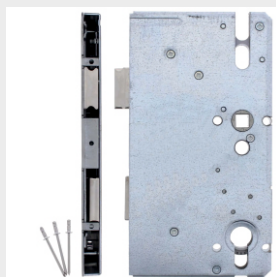

KFV 

Dornmaß: 90 mm
Entfernung: 92 mm
Vierkantmaß: 10 mm

T2020110001040-011



4260428554776

KFV Schlosskasten Typ 8092

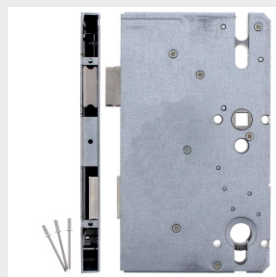

KFV 

Dornmaß: 100 mm
Entfernung: 92 mm
Vierkantmaß: 10 mm

T2020110001040-010



4260373823576

KFV Zusatzkasten AS2500

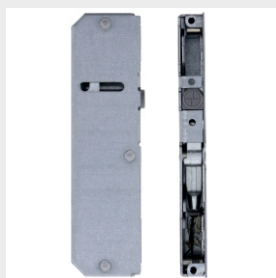

KFV 

inkl. Schwenkhaken

T2020110003511



426051 9567500

KFV Zusatzkasten AS2300



KFV 

inkl. Bolzen

T2020110003510



426051 9567494

KFV Zusatzkasten AS2750



KFV 

inkl. federnd gelagerter
Softlockfalle und einem
Schwenkriegel

für flache Treibstangen

Selbstverriegelnd

T2020110003513



426051 9567524

KFV Zusatzkasten AS2750



KFV 

Fallen-Schwenkhaken-
Kombination

doppelte Rundstangen-
aufnahme

T2020110008267



4061 334039971

SCHLOSSKÄSTEN

KFV Zusatzkasten AS4540



KFV

mit Schwenkhaken

T2020110008924



4061 334048379

ROTO MVZ Zusatzkasten



Roto

inkl. Bolzen

T2020110003507



426051 956741 8

ROTO MVZ Zusatzkasten



Roto

mit Schwenkriegel

T2020110003508



426051 9567432

ROTO MVZ Zusatzkasten



Roto

mit Bolzen und
Schwenkriegel

T2020110003509



426051 9567425



SCHNECKENGEHÄUSE

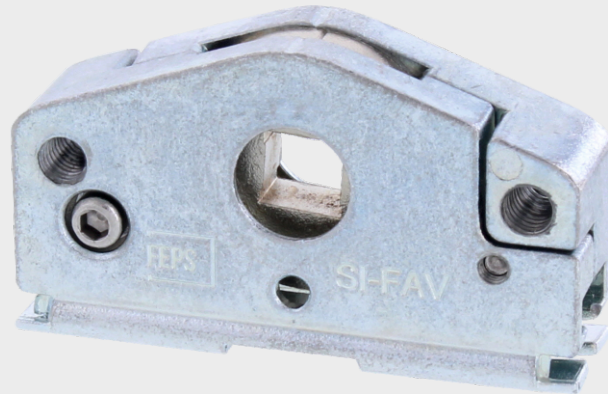

Inhaltsverzeichnis

BOX D14,5 bis D16	Seite 1
DORNMAß 7	Seite 1
DORNMAß 7,5	Seite 1 und 2
DORNMAß 14,5	Seite 2
DORNMAß 15	Seite 2 und 3
DORNMAß 15,5	Seite 3 und 4
DORNMAß 16	Seite 4
DORNMAß 17,5	Seite 4
DORNMAß 25	Seite 4 und 5
DORNMAß 30	Seite 5 und 6
DORNMAß 35	Seite 6
DORNMAß 37,5	Seite 6
DORNMAß 40	Seite 7
DORNMAß 45	Seite 7 und 8
DORNMAß 50	Seite 8

SCHNECKENGEHÄUSE

ToniTec Schneckengehäuse Erstausrüstung BOX



- 5 x Siegenia T2020110001464
- 5 x Winkhaus T2020110001463
- 5 x Roto T2020110001540
- 5 x FEPS T2020110004355
- 5 x AUBI T2020110001541
- 5 x MACO T2020110001538

Siegenia TRIAL FAVORIT D16 • Winkhaus D15,5 • Roto NT D15 •
FEPS Ersatzteil für Roto Centro 101 D14,5 • AUBI D15,5 • MACO D15

T2020110000183



4280465720981

FEPS Sortimentsbox Getriebegehäuse 30 tlg. BOX



- 5 x SI-FAV T2020110009063
- 5 x WI-AUT T2020110009062
- 5 x RO-NT T2020110009066
- 5 x SI-AGM T2020110009065
- 5 x MA-MU T2020110009064
- 5 x RO-CEN T2020110009067

SI-FAV Ersatz für Siegenia Serie Favorit D16 • WI-AUT Ersatz für Winkhaus Serie Autopilot D15,5
RO-NT Ersatz für Roto NT D15 • SI-AGM Ersatz für AUBI Serien AGM, AGK, AGMK und AGKK D15,5
MA-MU Ersatz für MACO D15 • RO-CEN Ersatz für Roto Centro 101 RO-CEN101 D14,5

T2022081002123



4064692002793

Siegenia TRIAL FAVORIT D7

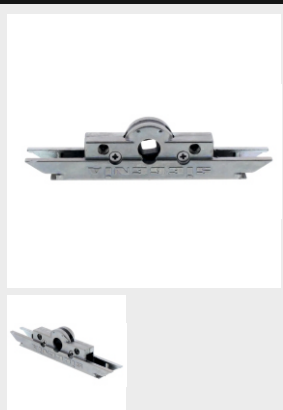

SIEGENIA
brings spaces to life

Dornmaß: 7 mm
Vierkant: 7 mm
schraubbar
ToniTec Upgrade



T2020110000987

426051 9566268

Roto Centro 101 D7,5

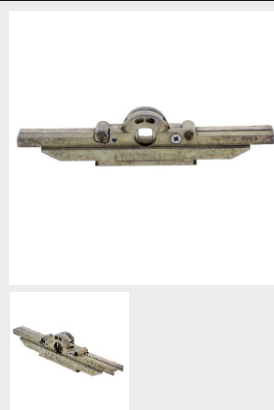

Dornmaß: 7,5 mm
Vierkant: 7 mm
schraubbar
ToniTec Upgrade



T2020110000419

42604931 79744

SCHNECKENGEHÄUSE



Winkhaus Schneckengehäuse D7,5



**WINK
HAUS**

Dornmaß: 7,5 mm

Vierkant: 7 mm

schraubbar

ToniTec Upgrade



T2020110000420



42604931 781 36

FEPS Schneckengehäuse D14,5



FEPS

Dornmaß: 14,5 mm

Vierkant: 7 mm

schraubbar

als Ersatz für Fenster-
getriebe der Marke Roto
Serie Centro 101 D14,5



T2020110009067



4064692000072

FEPS Schneckengehäuse D15



FEPS

Dornmaß: 15 mm

Vierkant: 7 mm

schraubbar

Ersatzteil für Maco



T2020110009064



4064692000038

FEPS Schneckengehäuse D15



FEPS

Dornmaß: 15 mm

Vierkant: 7 mm

schraubbar

Ersatz für Roto NT
Getriebe



T2020110009066



4064692000034

MACO Schneckengehäuse D15



maco

Dornmaß: 15 mm

Vierkant: 7 mm

schraubbar

ToniTec Upgrade



T2020110001538



4260373821 527

ROTO Schneckengehäuse D15



Roto

Dornmaß: 15 mm

Vierkant: 7 mm

schraubbar

ToniTec Upgrade



T2020110003276



426051 9568726

SCHNECKENGEHÄUSE

Roto Schneckengehäuse NT D15



Dornmaß: 15 mm

Vierkant: 7 mm

schraubbar

ToniTec Upgrade



T2020110001540



4260373821 541

Weidmann Schneckengehäuse Kurier 2 D15



Dornmaß: 15 mm

Vierkant: 7 mm

schraubbar

ToniTec Upgrade



T2020110001754



42603738251 29

FEPS Schneckengehäuse D15,5



Dornmaß: 15,5 mm

Vierkant: 7 mm

schraubbar

Ersatz für Winkhaus



T2020110009062



4064692000027

FEPS Schneckengehäuse 15,5



Dornmaß: 15,5 mm

Vierkant: 7 mm

schraubbar

Ersatz für AUBI



T2020110009065



4064692000041

AUBI Schneckengehäuse D15,5



Dornmaß: 15,5 mm

Vierkant: 7 mm

schraubbar

ToniTec Upgrade



T2020110001541



4260373821 558

Weidmann Schneckengehäuse Kurier 1 D15,5



Dornmaß: 15,5 mm

Vierkant: 7 mm

inkl. Schlagnieten

ToniTec Upgrade



T2020110001801



42603738251 8

SCHNECKENGEHÄUSE



Winkhaus Schneckengehäuse D15,5



**WINK
HAUS**

Dornmaß: 15,5 mm

Vierkant: 7 mm

schraubbar

ToniTec Upgrade



T2020110001463



4260428559559

Winkhaus Schneckengehäuse D15,5



**WINK
HAUS**

Dornmaß: 15,5 mm

Vierkant: 7 mm

Alte Ausführung

schraubbar

ToniTec Upgrade



T2020110001539



4260373821534

FEPS Getriebe SI-FAV D16



FEPS

Dornmaß: 16 mm

Vierkant: 7 mm

schraubbar

Ersatz für Siegenia
FAVORIT



T2020110009063



4064692000003

Siegenia TRIAL FAVORIT D16



SIEGENIA[®]
brings spaces to life

Dornmaß: 16 mm

Vierkant: 7 mm

Getriebe 3 & 23

schraubbar

ToniTec Upgrade



T2020110001464



4260264593564

Hautau Schneckengehäuse D17,5



H **HAUTAU**
OPENS NEW DIMENSIONS

Dornmaß: 17,5 mm

schraubbar

ToniTec Upgrade



T2020110000988



4260519566299

MACO Schneckengehäuse D25



maco

Dornmaß: 25 mm

Vierkant 7 mm

schraubbar

ToniTec Upgrade



T2020110000950



4260519564332

SCHNECKENGEHÄUSE

Roto Centro D25



Dornmaß: 25 mm

Vierkant: 7 mm

schraubbar

ToniTec Upgrade



T2020110002101



4260428555995

Winkhaus Schneckengehäuse D25



Dornmaß: 25 mm

Vierkant: 7 mm

inkl. Schlagnieten

ToniTec Upgrade



T2020110002110



4260264593571

Siegenia Schneckengehäuse D25



SIEGENIA
brings spaces to life

Dornmaß: 25 mm

Vierkant: 7 mm

inkl. Schlagnieten

ToniTec Upgrade



T2020110009808



4260428555988

MACO Schneckengehäuse D30



Dornmaß: 30 mm

Vierkant: 7 mm

schraubbar

ToniTec Upgrade



T2020110000951



4260519564349

Roto Centro D30



Dornmaß: 30 mm

Vierkant: 7 mm

schraubbar

ToniTec Upgrade



T2020110002102



4260428556008

Winkhaus Schneckengehäuse D30



Dornmaß: 30 mm

Vierkant: 7 mm

schraubbar

ToniTec Upgrade



T2020110002111



4260428555888

SCHNECKENGEHÄUSE



Siegenia Schneckengehäuse D30



SIEGENIA
brings spaces to life

Dornmaß: 30 mm

Vierkant: 7 mm

inkl. Schlagnieten

ToniTec Upgrade



T2020110002106



4260428555971

MACO Schneckengehäuse D35



Dornmaß: 35 mm

Vierkant: 7 mm

schaubar

ToniTec Upgrade



T2020110000952



426051 9564356

Roto Centro D35



Dornmaß: 35 mm

Vierkant: 7 mm

schaubar

ToniTec Upgrade



T2020110002103



4260428556015

Siegenia Schneckengehäuse D35



SIEGENIA
brings spaces to life

Dornmaß: 35 mm

Vierkant: 7 mm

inkl. Schlagnieten

ToniTec Upgrade



T2020110009809



4260428555964

Winkhaus Schneckengehäuse D35



Dornmaß: 35 mm

Vierkant: 7 mm

schaubar

ToniTec Upgrade



T2020110002112



4260428555896

Siegenia Hauptschloss D37,5



SIEGENIA
brings spaces to life

Dornmaß: 37,5 mm

für HS Portal Getriebe



T2020110000989



426051 9566305

SCHNECKENGEHÄUSE

Roto Centro Schneckengehäuse D40



Dornmaß: 40 mm

Vierkant: 7 mm

schraubbar

ToniTec Upgrade



T2020110001537



4260373821503

MACO Schneckengehäuse D40



Dornmaß: 40 mm

Vierkant: 7 mm

schraubbar

ToniTec Upgrade



T2020110000953



4260519564363

Siegenia Schneckengehäuse D40



SIEGENIA
brings spaces to life

Dornmaß: 40 mm

Vierkant: 7 mm

schraubbar

ToniTec Upgrade



T2020110002107



4260428555957

Winkhaus Schneckengehäuse D40



Dornmaß: 40 mm

Vierkant: 7 mm

schraubbar

ToniTec Upgrade



T2020110002113



4260428555902

MACO Schneckengehäuse D45



Dornmaß: 45 mm

Vierkant: 7 mm

schraubbar

ToniTec Upgrade



T2020110000969



4061334069725

Roto Centro D45



Dornmaß: 45 mm

Vierkant: 7 mm

schraubbar

ToniTec Upgrade



T2020110002104



T2020110002104

SCHNECKENGEHÄUSE



Siegenia Schneckengehäuse D45



SIEGENIA
brings spaces to life

Dornmaß: 45 mm
Vierkant: 7 mm
schraubbar
ToniTec Upgrade

T2020110002108



4260428555940

Winkhaus Schneckengehäuse D45



**WINK
HAUS**

Dornmaß: 45 mm
Vierkant: 7 mm
schraubbar
ToniTec Upgrade

T2020110002114



4260428555919

Roto Centro D50

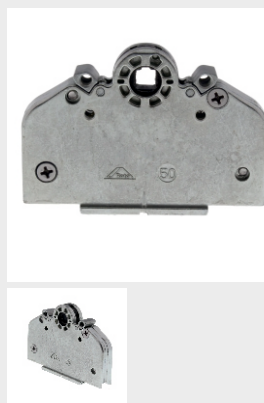

Roto

Dornmaß: 50 mm
Vierkant: 7 mm
schraubbar
ToniTec Upgrade

T2020110002105



42604285556039

Siegenia Schneckengehäuse D50



SIEGENIA
brings spaces to life

Dornmaß: 50 mm
Vierkant: 7 mm
schraubbar
ToniTec Upgrade

T2020110002109



4260428555933

MACO Schneckengehäuse D50



maco

Dornmaß: 50 mm
Vierkant: 7 mm
schraubbar
ToniTec Upgrade

T2020110000956



4260519567180

Winkhaus Schneckengehäuse D50



**WINK
HAUS**

Dornmaß: 50 mm
Vierkant: 7 mm
schraubbar
ToniTec Upgrade

T2020110002115



4260428555926



SONDERLÖSUNGEN

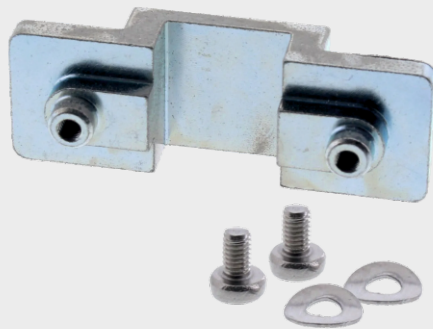

SONDERLÖSUNGEN

ToniTec Kippriegelbauteil mit Kupplungsstück



 TONITEC®

für Siegenia FAVORIT Kippriegelbauteil, alte Variante

T2020110000386



FEPS Schwinge und Zapfen SI-SW001



 FEPS

Ersatzteil für Siegenia Kippriegelbauteil
schraubbar

T2021101005136



ToniTec Schwinge mit Zapfen



 TONITEC®

Ersatz für Siegenia TL Ausführung
schraubbar

T2020110004359





Kippriegel für Roto Centro Stulpflügelgetriebe

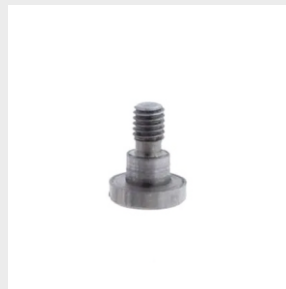

 **TONITEC**[®]

Euronut M340 mit ToniTec Upgrade
Roto Stulpflügelgetriebe M340 6482388800
schraubbar

T2020110000991



426051 9566343

Hautau Schneckengehäuse D17,5 mm



 **HAUTAU**
OPENS NEW DIMENSIONS

Dornmaß: 17,5 mm
schraubbar
mit ToniTec Upgrade

T2020110000988



426051 9566299

Siegenia Hauptschloss für HS Portal Getriebe



 **SIEGENIA**[®]
brings spaces to life

Original Siegenia Hauptschloss zur Reparatur von HS Portal Getrieben

T2020110000989



426051 9566305

SONDERLÖSUNGEN

ToniTec Mitnehmer für Winkhaus GPMS Getriebe



 TONITEC®

schraubbar

T2020110004354



ToniTec Reproduktion HAUTAU Kupplungsflasche für HKS Getriebe



 TONITEC®

inkl. Schrauben
Lochabstand: 30 mm
Aufnahme für Getriebegriff: 14 mm
Maß: 8 mm x 16 mm x 46 mm

T2020110004356



Schüco Kupplungsstück 276268



 SCHÜCO

für PSK Türen
Besteht aus den GU Teilen: GU 37219 und GU 37220

T2020110004330





ToniTec Schließwinkel für Siegenia Schere



 **TONITEC**[®]

schraubbar
inkl. 2 Schrauben

T2021121005660



ToniTec Schließwinkel-Element Winkhaus

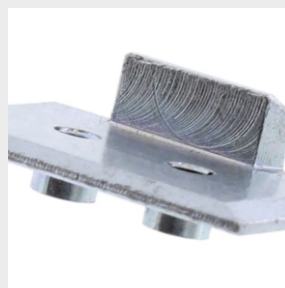

 **TONITEC**[®]

schraubbar
für Winkhaus Pilot/ AutoPilot Scheren

T2020110004365



ToniTec UNI-ECK Universal Eckmklung Reparatur-Set

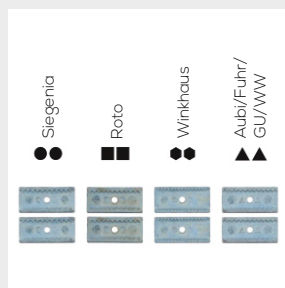
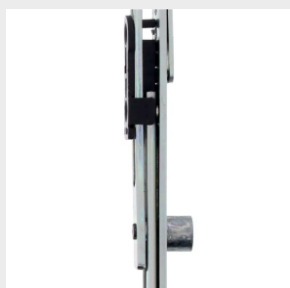

 **TONITEC**[®]

150 x 150 mm
kann Getriebe verschiedener Hersteller kombinieren

T2020110009432



SONDERLÖSUNGEN

ToniTec UNI-ECK 2 Universal Eckumlenkung Reparatur-Set

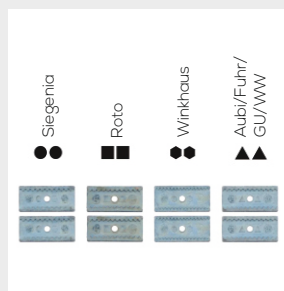

150x190

kann Getriebe verschiedener Hersteller kombinieren

T2020110004367



4061 334039803

ToniTec Reparatur-Eckumlenkung Uni-Eck

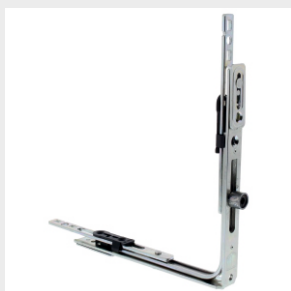

150x150 mm
ohne Zahnschuhe

T2020110004360



4061 334022805

ToniTec Reparatur-Eckumlenkung Uni-Eck-2

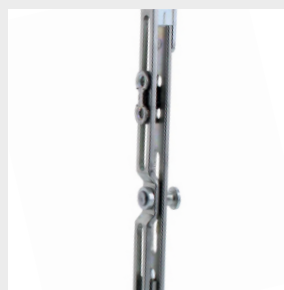

190x150 mm
ohne Zahnschuhe

T2020110004366



4061 334039797



ToniTec Zahnverbindungsteil EFA Roto

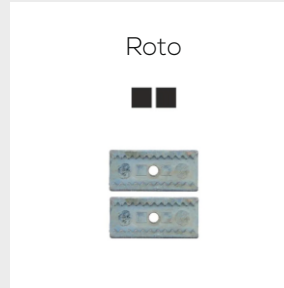

Quadratisches Zeichen

T2020110004361



ToniTec Zahnverbindungsteil EFA Siegenia



Kreisförmiges Zeichen

T2020110004362



ToniTec Zahnverbindungsteil EFA Winkhaus



Sechseckiges Zeichen

T2020110004363



SONDERLÖSUNGEN

ToniTec Zahnverbindungsteil EFA Weidmann, GU, Aubi, Fuhr



Dreieckiges Zeichen

T2020110004364



4061 334022843

FEPS Verlängerung für Siegenia Kippriegelbauteile SI-KR001



Für Beschlagssystem Siegenia Favorit

Material: Stahl

Oberfläche: verzinkt

Maße: 120 x 12 x 13 mm

T2021061004484



40646920001 88

FEPS Schlosstasche DIN-Links FE-ST001 LS



Material: Edelstahl

DIN-Richtung: DIN-Links

Maße: 221 x 85 x 18 mm

T2021121005612



4064692000522



FEPS Schlosstasche DIN-Rechts



FEPS

Material: Edelstahl
DIN-Richtung: DIN-Links
Maße: 221 x 85 x 18 mm

T2021121005611





UNSERE LIEFERANTEN



und viele weitere.



Ihr starker Partner im Ersatzteilgeschäft!



Mithilfe des Barcode-Scanners in der TONITEC-APP können Sie schnell und einfach weitere Bilder und Informationen zum jeweiligen Artikel abrufen.



Jens Rothe

+49 (0) 333230851-15
J.ROTHE@TONITEC.COM



John-Patrick Winkel

MOBIL: +49 (0) 172 5977215
J.WINKEL@TONITEC.COM



Marcel Baumert

+49 (0) 333230851-12
M.BAUMERT@TONITEC.COM

TONITEC GMBH
ACKERSTR. 4
16303 SCHWEDT/ODER
TONITEC.COM

TEL. +49 (0) 3332 308 51-0
FAX +49 (0) 3332 308 51-90
KUNDENSERVICE@TONITEC.COM

